



Polymetallic Nodules

- Chemical Composition
- Theories of Formation
- Geographical Distribution
- Exploration Technologies
- Processing Technologies

NATURE OF THE MINERALS

Polymetallic nodules were discovered at the end of the 19th century in the Kara Sea, in the Arctic Ocean off Siberia (1868). During the scientific expeditions of the H.M.S. Challenger (1872-76), they were found to occur in most oceans of the world.

Polymetallic nodules, also called manganese nodules, are rock concretions formed of concentric layers of iron and manganese hydroxides around a core. The core may be microscopically small and is sometimes completely transformed into manganese minerals by crystallization. When visible to the naked eye, it can be a small test (shell) of microfossil (radiolarian or foraminifer), a phosphatized tooth of shark, basalt debris or even fragments of earlier nodules. The thickness and regularity of the concentric layers are determined by the successive stages of growth. On some nodules they are discontinuous, with noticeable differences between the two sides. Nodules vary in size from tiny particles visible only under a microscope to large pellets more than 20 centimetres across. However most nodules are between 5 and 10 cm in diameter, about the size of potatoes. Their surface is generally smooth, sometimes rough, mammilated (knobby) or otherwise irregular. The bottom, buried in sediment, is generally rougher than the top.

The nodules lie on the sea-bottom sediment, generally half buried. Some nodules are completely covered by sediment and, in some areas, nodules have been collected even though they are invisible on photographs. They vary greatly in abundance. In some places they cover more than 70 percent of the bottom, the nodules touching one another. However it is considered that, to be of economic interest, the abundance must exceed 10 kilograms per square metre, with an average of 15 kg/m² over areas of several tenths of a square kilometre. They can occur at any depth, but the highest concentrations have been found between 4,000 and 6,000m.



Polymetallic nodules.

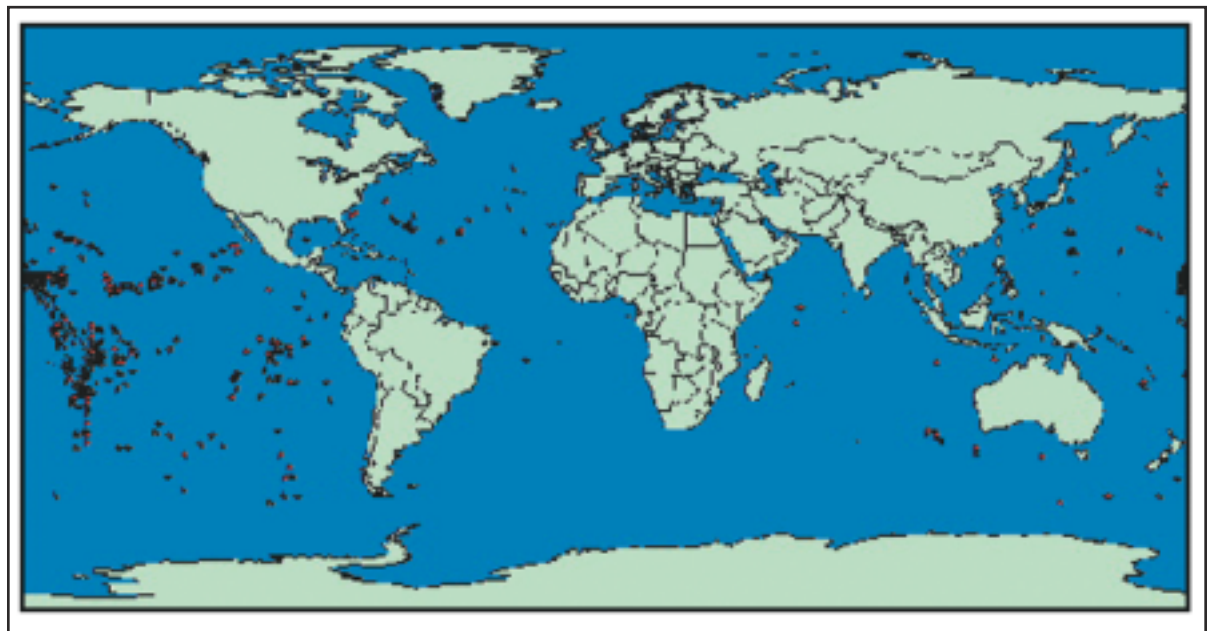

World map showing the occurrence of polymetallic nodules.

Chemistry

The chemical composition of nodules varies according to the kind of manganese minerals and the size and characteristics of the core. Those of economic interest have the following constituents:

Manganese	...29%
Iron6%
Silicon5%
Aluminum3%
Nickel*1.4%
Copper*1.3%
Cobalt*0.25%
Oxygen1.5%
Hydrogen1.5%
Sodium1.5%
Calcium1.5%
Magnesium	...0.5%
Potassium0.5%
Titanium0.2%
Barium0.2%

*nickel, copper, and cobalt are the most valuable.

Formation

Several theories have been proposed to explain the formation of different types of nodules.

Two of the more popular are :

1. A hydrogenous process in which concretions are formed by slow precipitation of the metallic components from seawater. This is thought to produce nodules with similar iron and manganese content and a relatively high grade of nickel, copper and cobalt.
2. A diagenetic process in which the manganese is remobilized in the sediment column and precipitates at the sediment/water interface. Such nodules are rich in manganese but poor in iron and in nickel, copper and cobalt.

Other proposed mechanisms

- A hydrothermal process, in which the metals derive from hot springs associated with volcanic activity;
- A halmyrolitic process, in which the metallic components come from the decomposition of basaltic debris by seawater;
- A biogenic process, in which the activity of microorganisms catalyzes the precipitation of metal hydroxides.

Common Factors

Several of these processes may operate concurrently or may follow one another during the formation of a nodule. Whichever of them is operative in particular cases, a number of common factors have been established:

1. Nodule formation requires a low rate of sedimentation or some process for removing sediment before it accumulates. This enables concretions to grow before they are buried, when they would be cut off from the conditions that allow them to develop.
2. Plankton concentrates trace elements such as copper and nickel. The organic matter that falls to the sea bottom when these organisms die is a probable source of the metals incorporated into the nodules.
3. Manganese in seawater comes mainly from hydrothermal vents (hot springs), where it is leached out of the underlying basalt as the superheated fluids percolate upwards through the oceanic crust.
4. Concretion is furthered by the activity of microorganisms.



Polymetallic nodules. (Christina Loarie)

Nodule growth is one of the slowest of all geological phenomena - in the order of a centimetre over several million years. The age of Pacific Ocean nodules is therefore 2 to 3 million years. However, rapid formation of ferromanganese crusts has been reported near ships wrecked during the First World War. Such fast growth has implications for the origin of the components and the way they come together. If nodules are formed slowly, hydrogenous or diagenetic processes might be at work, but if they are formed quickly, metal sources other than seawater or sediment are most probable. In the latter case, hydrothermal or even halmyrolitic processes are likely.



Cross-section of a Polymetallic nodule

Another factor requiring explanation is why the nodules remain on the surface when the sedimentation rate is much faster than nodule growth. Even for residual radiolarian ooze, the average rate of sedimentation is in the order of several millimetres per thousand years. Accordingly, the nodules should be buried under several metres of sediment. It is assumed that deposit-feeding benthic organisms (polychaete or echiurian worms) clean the recently settled particles atop the nodules and eject them on the sides or even below the nodules, thus preventing their burial.

GEOGRAPHICAL DISTRIBUTION

Nodules have been found in all the oceans and even in lakes. However, nodules of economic interest are more localized. Three areas have been selected by industrial explorers: the centre of the north central Pacific Ocean, the Peru Basin in the south-east Pacific Ocean and the centre of the north Indian Ocean.

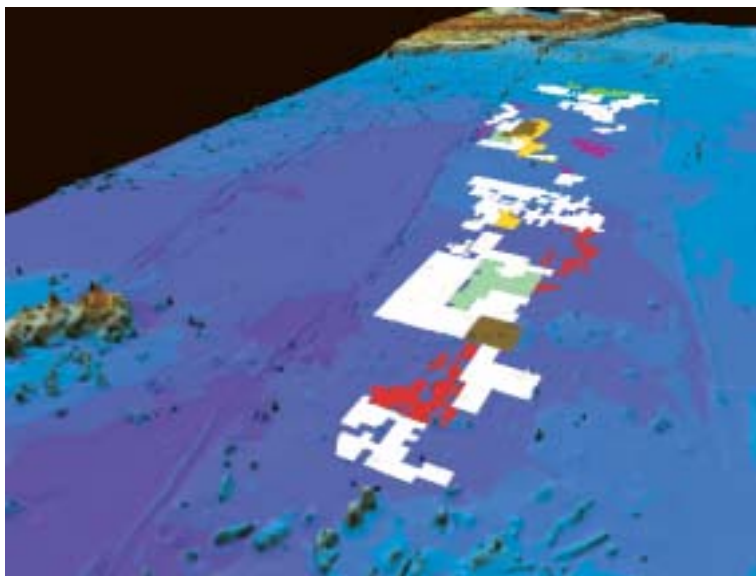

Reserved Areas of the ISA (white). Courtesy of the Law of the Sea Geoscience Group, Southampton Oceanography Centre, United Kingdom, 2003.

In these areas, the depth of the seabed is 4,000 to 5,000 metres. The bottom topography is formed of abyssal hills, elongated north to south in conformity with the scars of the ocean crust. These scars correspond to the fractures of basalt as the crust spreads out from the mid-ocean ridges. As it moves away from the ridge, the crust is progressively covered by sediments.

Thus, in the north Pacific, the sediment thickness increases westward from 50 to 150 m between 120 and 155 degrees west longitude. The crests of the hills, spaced apart by 2–5 km, rise 100–300m above the lowest areas. Vertical cliffs of calcareous clay up to 40 m high occur on the flanks of the hills and large potholes have been found on the crests. Nevertheless, despite these terrain obstacles, the average slope is less than 10%. Geostatistical simulation based on continuous photography of the bottom shows fields that are mineable. In the best areas, they would be 1 to 5 km wide and 10 to 18 km long, with a north-south orientation. They might cover 35% of the bottom with a nodule abundance of 15 kg/m².

The total amount of polymetallic nodules lying on the sea floor was estimated at more than 1.5 trillion tonnes by John Mero in 1965. The estimate was reduced to 500 billion tonnes by A.A. Archer in 1981. However, not all nodule fields are eligible for mining. Several attempts were made to calculate the probable resources for future development. These approaches started by determining the number of mine sites that the world's oceans could accommodate. A mine site was defined as a portion of the seabed where a commercial operation could be maintained for 20-25 years with a production of 1.5 to 4 million tonnes per year of "good nodules." Good nodules were defined as averaging at least 1.25–1.5% nickel and 1–1.4% copper, as well as 27–30% manganese and 0.2–0.25% cobalt. The estimation of the number of sites varied from 8 to 225, which corresponds to a total inferred resource of 480 to 13,500 million tonnes. Further considerations, including the capacity of the world metal market to absorb the production during the first 20 years, and more severe mining assumptions, reduced this range to 3–10 mine sites with a tonnage of 100–600 million tonnes. These statements constitute "speculative inferred resources."

Polymetallic Nodule Deposit

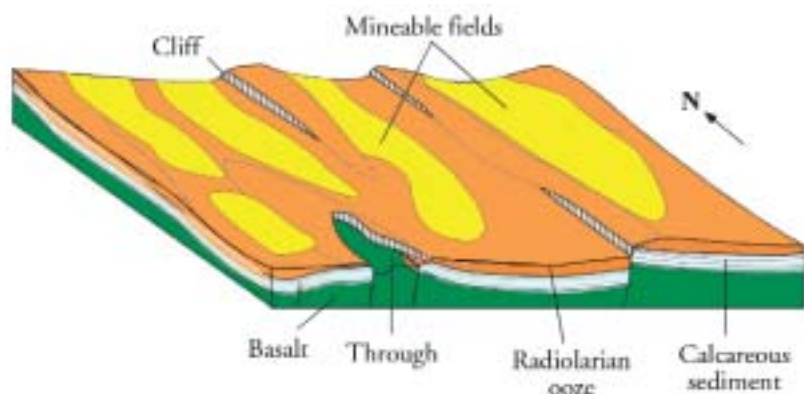

Mineable Fields in Prime Areas

Geostatistical simulation in the French pioneer area

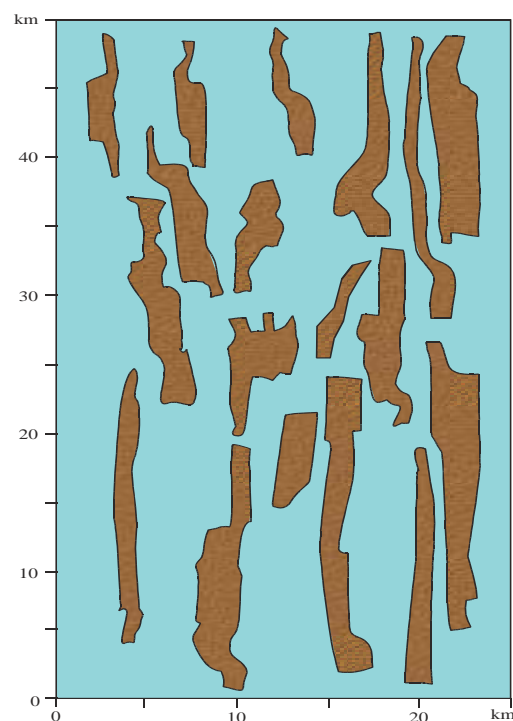

EXPLORATION TECHNOLOGIES

Various technological solutions have been devised in the course of exploration for polymetallic nodule deposits. Over the years, considerable improvements have been made in the technology for locating and sampling these resources. This information sheet reviews some of these technologies.

BOTTOM TOPOGRAPHY

Since the 1930s, echo sounding (sonar) has been used to investigate the topography of the ocean bottom. Conventional echo sounders emit sound waves in a broad-angle cone (40 degrees) pointed directly below a vessel. From the time interval separating the emission of a sound pulse and the reception of its echo from the seabed, the depth can be calculated, given the velocity of sound in the water (about 1,500 metres per second). Successive depth readings, measured as a ship proceeds, provide a profile of the topography beneath its route. To map a block of seabed accurately, equally spaced parallel courses must be traversed. At the end of the 1970s, multibeam echo sounders became available. They emit a series of acoustic signals in narrow beams (2°), arranged like a fan perpendicular to the ship's axis. Each emission results in a set of depth soundings corresponding to different points below and to the side of the vessel's route. Modern multibeam echo sounders (side-scan

sonar) produce more than 150 measurements for each swath (averaging one every 130 m), covering a width of 20 kilometres at a depth of 4,000 m. Many features can be identified that were previously invisible. A map is produced on board the ship within a minute, making it possible to "read," in real time, the topography of a strip of the bottom. The assemblage of adjacent strips is easily done by computer. With the Global Positioning System (GPS) giving a 1-m accuracy, the resulting map is as precise as the best topographic maps on land at a scale of 1 to 25,000. Surveying from the surface is supplemented by deep-tow sonar pulled along above the seabed. Most explorers have used free-fall devices that can descend to the bottom, take samples and photographs, and return to the surface on their own. In each dive they can collect a few kilograms of nodules from an area of 0.25 m^2 and take pictures covering 2 to 4 m^2 . By combining this information, the abundance of nodules on the bottom can be estimated in kilograms per square metre. Grabs and cameras operated by cable give information that is more reliable but they are slower. Recent improvements in sonar technology should facilitate the development of new apparatus better able to measure the density of nodule coverage. It will be then possible to map nodule abundance over larger areas in a shorter time.

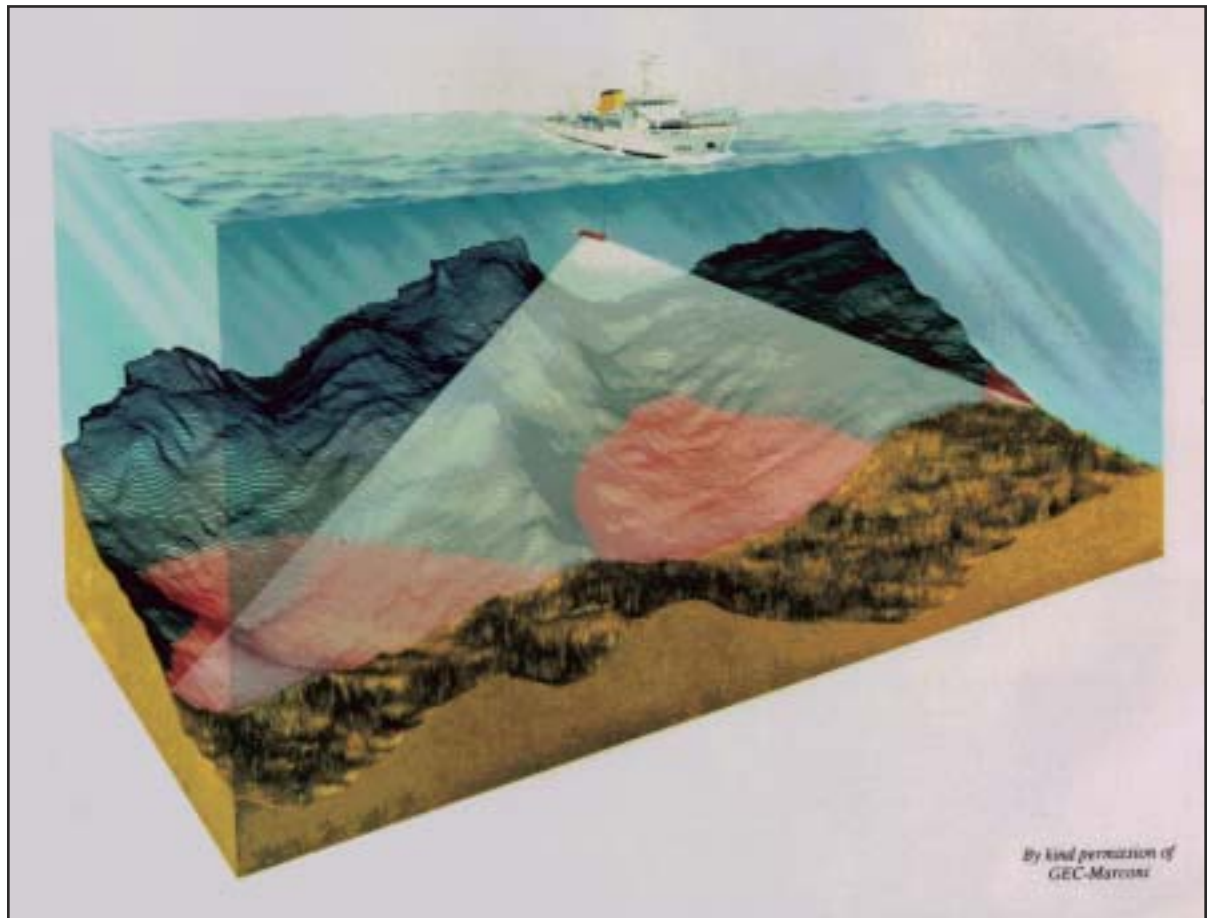

Multi-beam echo sounder model

MINING TECHNOLOGIES

The technologies used for mining and processing will largely determine which areas are suitable for nodule exploitation. Nodules must be sufficiently abundant if they are to be collected efficiently by mining equipment. Also, they must be high enough in grade, or proportion of the desired metals to total bulk, for metallurgical processes to recover the valuable commodities economically.

The first trial of a prototype nodule-mining system occurred in 1970 on the Blake Plateau, off Florida in the Atlantic Ocean, at a depth of 1,000 m. Deep Sea Ventures, the operator, equipped the Deep Sea Miner, a 6,750-t freighter, with a 25-m derrick and a 6 by 9 m central pool (the space from which the mining device is deployed).

The nodules were raised by airlift, a system previously tested in a 250-m mine shaft.

In 1972, a syndicate of 30 companies tested a system invented by Yoshio Masuda, a Japanese marine officer. The Continuous Line Bucket (CLB) consisted of an 8-km cable on which buckets were attached at regular intervals. The buckets were launched from the bow of a former whaling ship, the Akurei Maru, and recovered at the stern. Some nodules were picked up, but the test was stopped by entanglements of the line. A new test planned for 1975, using two ships instead of one, had to be cancelled for lack of funds.

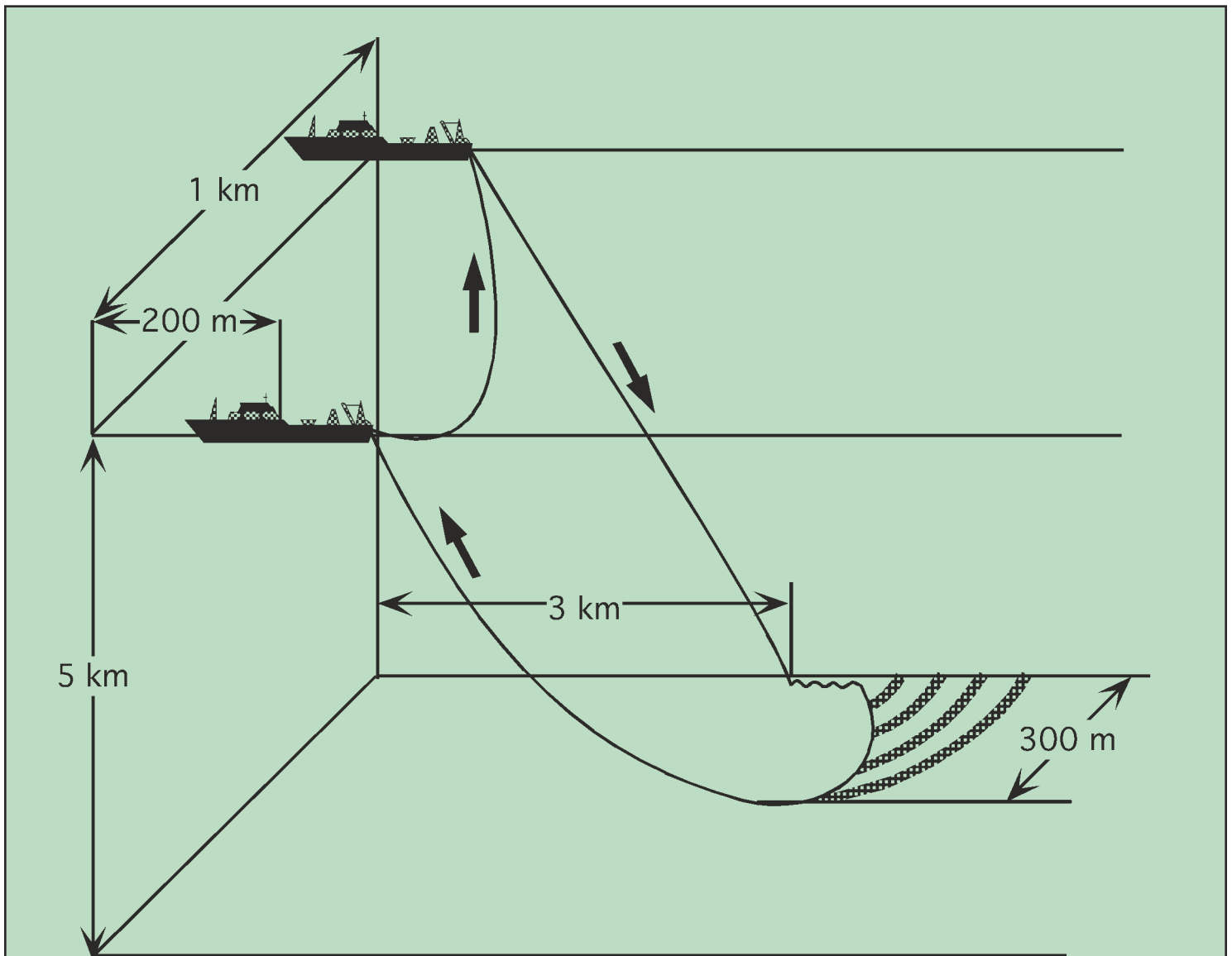

**THE CLB SYSTEM
(Continuous Line Bucket)
with two vessels**

At the end of the 1970s, three United States consortia conducted mining tests in the Pacific Ocean with hydraulic mining systems. The nodules, collected on the bottom by a dredge, were transferred to the base of an uptake pipe suspended beneath the surface ship. Ocean Management Incorporated (OMI) used a drilling ship with dynamic positioning, the SEDCO 445. It was equipped with a derrick suspended by gimbals, which reduced the transmission of the ship's movements to the uptake pipe. Two lifting systems were tested: pumping with centrifugo-axial pumps implanted in the pipe at a depth of 1,000 m, and lifting by injection of compressed air between 1,500 and 2,500 m (airlift). Two collecting devices were towed behind the pipe: a hydraulic suction dredge with water jets and a mechanical collector with an inverse conveyor belt. Unfortunately, the first collector was lost during a false manoeuvre. However, about 600 tonnes of nodules were harvested during the three tests, which were conducted 1,250 km south of Hawaii.

In 1976, Ocean Mining Associates (OMA) equipped the Wesser Ore, a 20,000-t ore carrier, with a moon pool (an opening in the hull for drilling equipment to pass), a derrick and revolving thruster. The nodules were collected by a suction dredge towed on skis and were raised by airlift. The ship, renamed Deepsea Miner II, conducted its first tests in 1977 at 1,900 km

southwest of San Diego, California. The tests were suspended because the electric connectors along the pipe string were not completely waterproof. Early in 1978, two further trials encountered new difficulties when the dredge founder in bottom sediment and a hurricane struck. Finally in October 1978, 550 tonnes of nodules were lifted in 18 hours, at a maximum capacity of 50 t/h. The test was stopped after the breakdown of a blade in the suction pump, causing its electric motor to fail.

In 1978, Ocean Minerals Company (OMCO) rented the Glomar Explorer from the United States Navy. This dynamic positioning vessel had a 33,000-t displacement and a length of 180 m. It utilized a sophisticated system to deploy the pipe string and electric power conduits. Its large moon pool (61 x 22 m) facilitated the handling of a large collector. OMCO built a motorized collector outfitted with Archimedes screws to crawl over soft sediment. After several experiments at a depth of 1,800 m off California, the first tests, south of Hawaii at the end of 1978, were suspended because the doors of the moon pool refused to open. Finally in February 1979, the operation was carried out with success. In addition, much data was assembled by the ship's advanced computer system. These operations succeeded in demonstrating that the basic approach to dredging and lifting was correct.

Hydraulic Mining System

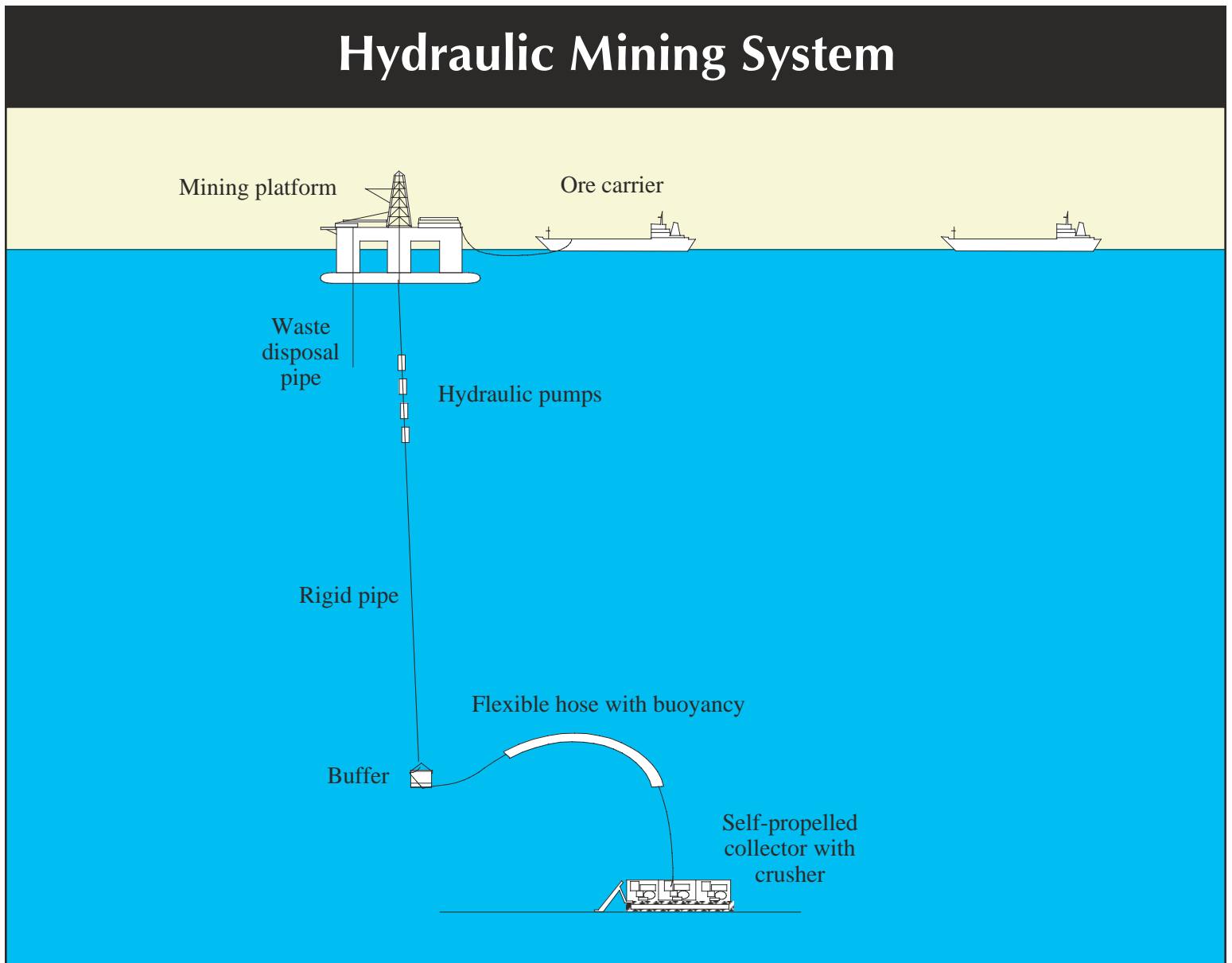

In 1979, the difficulties caused by terrain obstacles on the ocean floor, such as blocks, steps, cliffs and potholes, convinced French engineers to give more freedom to the bottom collector. They worked on the concept of a free-shuttle mining system consisting of a series of independent vehicles that would dive on their own to the ocean floor. Reaching the bottom, they would dump ballast to position themselves carefully and would start to collect the nodules. Powered by lead batteries, they would crawl on caterpillar tracks, adjusting their weight by the release of ballast. After loading 250 tonnes of nodules, they would drop additional ballast and start their ascent to the surface. There, they would be dragged to a floating port. Unfortunately, it was found during the feasibility study that the system would be too expensive, because the 1,200-t weight of the shuttles far exceeded their 250-t loading capacity. The problems lay in the weak performance of available buoyant materials and/or the high ratio of weight to energy in the lead batteries.

Hydraulic systems now seem to have the greatest potential. Such a system was conceptualized in 1988 by the French GEMONOD (Groupement pour la mise au point des moyens nécessaires à l'exploitation des nodules). It consisted of: a semi-submersible surface platform, catamaran type; a 4,800-m rigid steel pipe string, and a flexible hose, 600 m long and with a 38-centimetre internal diameter, connecting the bottom of the pipe string to a dredge on the seabed. This hose would form an arc, allowing the dredge to deviate from the route followed by the surface platform so as to avoid obstacles.

The self-propelled dredge would be 18 m long, 15 m wide and 5 m high, weighing 330-t for a 78-t buoyancy. Crawling on the bottom, it would collect nodules and condition them for pumping through the flexible hose.

Ore carriers would transport the nodules from mining ship to port, where the processing plant would be located. The nodules would be transferred, into and out of the carrier's hold, as thick slurry, pumped through a flexible hose. At the processing site the slurry would be stored in ponds.

India is currently developing a mining vehicle that it plans to test in 2007-08. The Director of the National Institute of Ocean Technology told a workshop organized in 2001 by the International Seabed Authority that his organization had already tested a prototype at 410 m and planned a further test at 6,000 m in 2002. The device, 3 m wide, would crawl over the seabed on plastic tracks. A pick-up device in front would gather the nodules, which would be lifted by a conveyor belt into a crusher. The system was designed to vibrate so that silt would not be carried into the crusher. The crushed nodules would pass into a flexible hose 10 cm in diameter, through which they would be pumped up to a vessel at the surface. A second umbilical connection would carry power and communications cables. Though tethered to the surface vessel, the crawler would move about independently on the seabed. Its developers describe this system as more friendly to the environment than earlier ones.



Nodule field

Photo: IFREMER



Scientists preparing to remove sediment samples from a multiple corer (Christina Loarie)

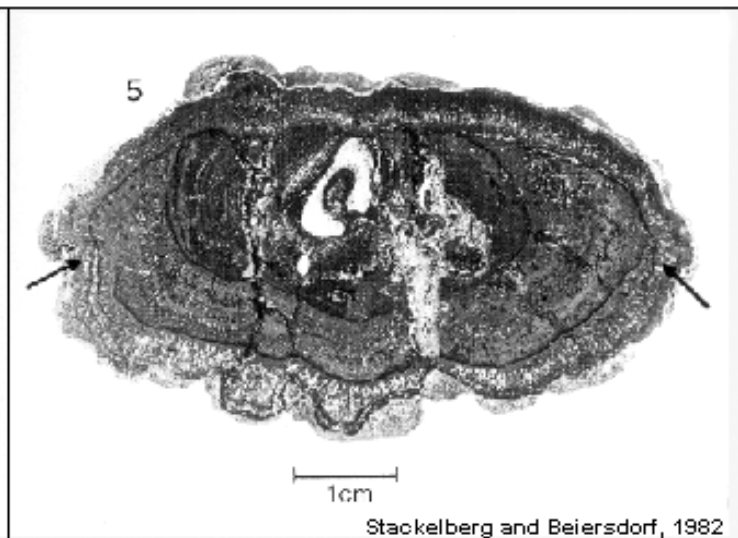
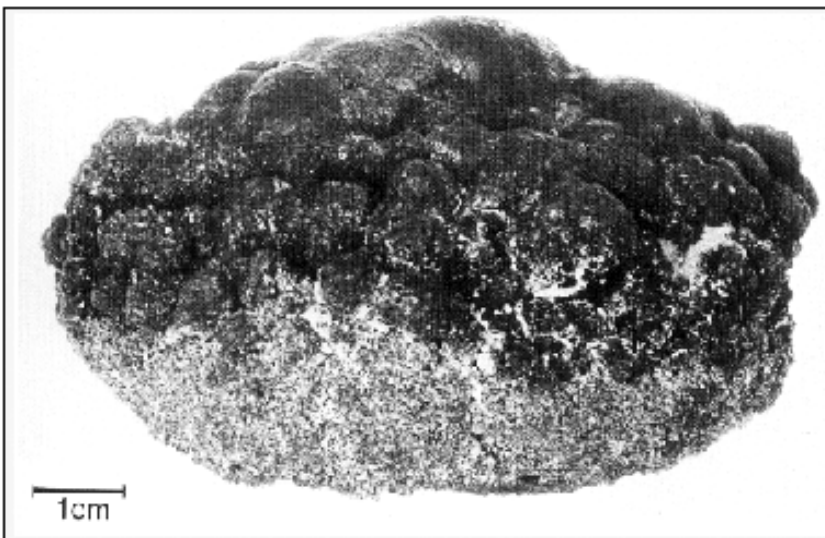

A polymetallic nodule and its cross section

Stackelberg and Beiersdorf, 1982

PROCESSING TECHNOLOGIES

Many processes have been investigated to treat polymetallic nodules. Initially the extraction of only three metals was considered: nickel, copper and cobalt. After 1978, manganese was added to increase total revenue and reduce the amount of waste. The technologies are of two types: hydrometallurgy, in which the metals are leached from the nodules by acid (hydrochloric or sulphuric) or basic (ammonia) reagents, and smelting, in which the hydroxides are reduced (stripped of oxygen) and the melted metals separated by gravity. Three examples are outlined below.

lurgy, in which the metals are leached from the nodules by acid (hydrochloric or sulphuric) or basic (ammonia) reagents, and smelting, in which the hydroxides are reduced (stripped of oxygen) and the melted metals separated by gravity. Three examples are outlined below.

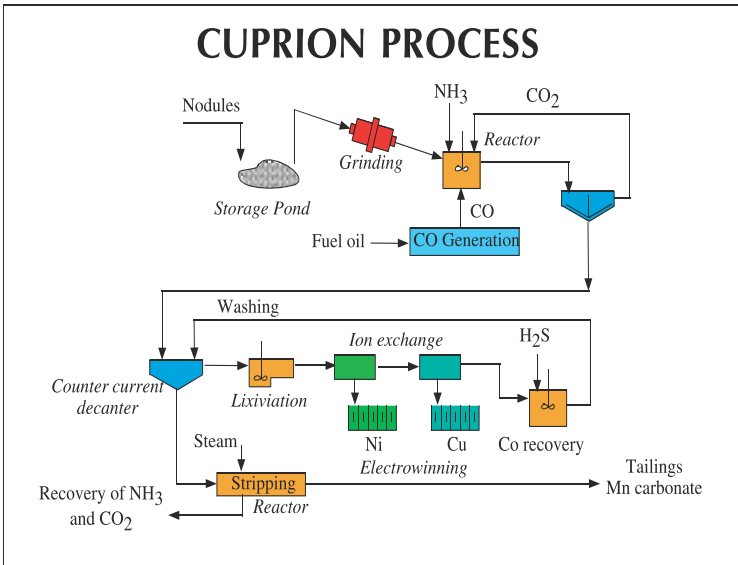

Cuprion Process

The Cuprion process was developed by Kennecott. The nodules are ground to a fine slurry, which is reduced by carbon monoxide in an agitated tank at low temperature, in the presence of ammonia. The copper, nickel and cobalt are made soluble by counter-current decanting in a series of thickeners. The nickel and copper are then extracted by liquid ion exchange combined with electrowinning (separation by electrolysis), and the cobalt is removed by sulphide precipitation. However, recovery of manganese from the ferromanganese residue was found to be difficult.

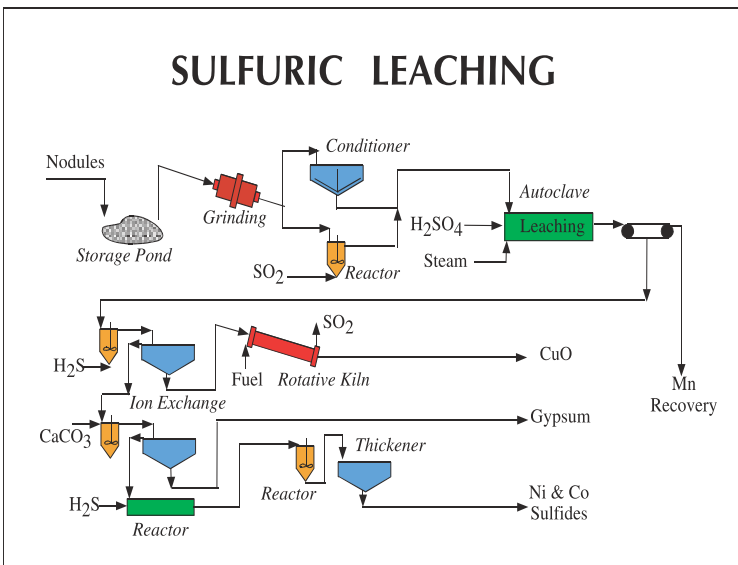

Sulphuric Leaching

This process was proposed by Fuerstenau in 1973, and later considerably improved in studies by the French Commissariat à l'Énergie Atomique. The metals in the crushed nodules are dissolved by sulphuric acid at 180° Celsius and a pressure of 1,200 kilopascals. Bivalent manganese ions, formed by pre-reduction of some of the nodules with sulphuric gas, are introduced into an autoclave (steam-pressured heating chamber) to increase the recovery of cobalt. Copper, nickel and cobalt are precipitated from the resulting solution using hydrogen sulphide. The copper sulphide is roasted to give an oxide concentrate, while the nickel-cobalt concentrate is kept as a sulphide.

At the refinery, the copper oxide concentrate is leached by sulphuric acid and the metal extracted by electrowinning. The nickel-cobalt sulphide concentrate is melted in chlorine and water. After elimination of the iron and zinc, the two remaining metals are separated by ion-exchange solvents. The cobalt is produced as a chloride to be sent to a cobalt refinery and the nickel is extracted by electrolysis. The ferromanganese residue is smelted after drying and calcination in an electric furnace, where the phosphorus is eliminated along with part of the iron.

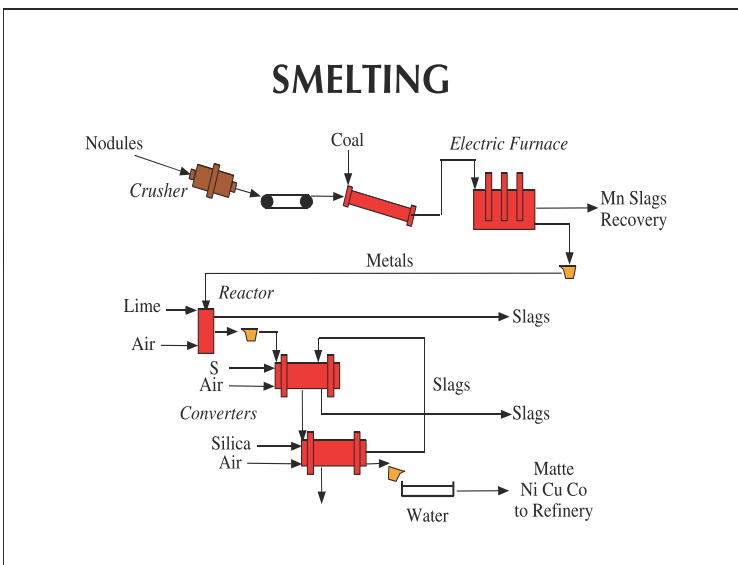

Smelting

Several companies have studied the application of classical nickel and copper smelting processes to the treatment of polymetallic nodules. After drying and calcination in a rotary kiln, the nodules are introduced into a submerged electric-arc furnace for reduction. A manganese-rich slag and an iron-nickel-copper-cobalt alloy are produced. The alloy is refined in a converter, where oxidation removes most of the remaining manganese and iron. Then, by adding sulphur, a nickel-copper-cobalt matte is obtained. The matte can be treated by several methods used in the nickel industry. For example, it may be ground before selective leaching with chlorine. After elimination of the sulphur from the copper solution, the nickel is extracted by ion exchange and electrolysis. The iron and zinc in the nickel-cobalt solution are eliminated before ion-exchange extraction of the cobalt and nickel. The hot manganese-rich slag is fed directly to an electric-arc furnace, where the phosphorus and residual heavy metals (nickel, copper and cobalt) are eliminated, along with much of the iron, to produce a ferro-silico-manganese alloy.